

# THERMOSTAT D'AMBIANCE ÉLECTRONIQUE

# METR 75810

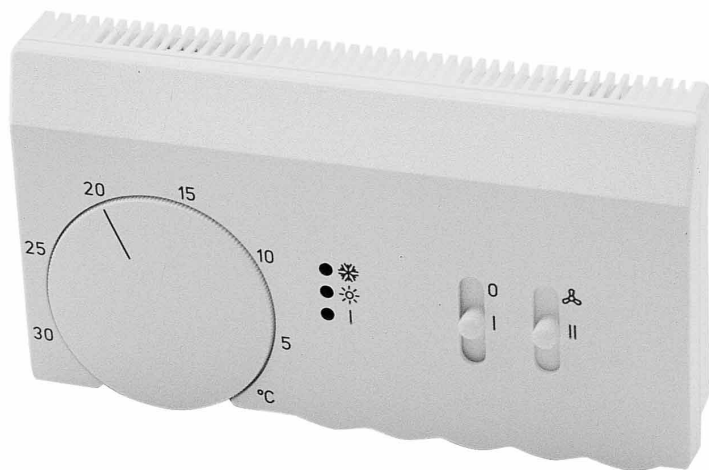

Alimentation	230V~
Pouvoir de coupure	250V~
Commutateur glissant	6(2)A
Contact de chauffage	8(3)A
Contact de réfrigération	5(2)A
Protection	IP 30
Un montage correct assure une protection classe II	
Plage	5-30 °C
Max. humidité	95%rH
Non condensant	

**Attention!**  
 Cette boîte ne doit être ouverte que par un spécialiste technique et doit être installée selon le schéma des connexions indiqué sur le couvercle. Il est indispensable de respecter les prescriptions de sécurité.  
 Cet appareil ne peut être installé que sur une surface plane, stable et non conductible!  
 Résistant à la pollution normale!

Des modifications techniques peuvent être introduites préavis.

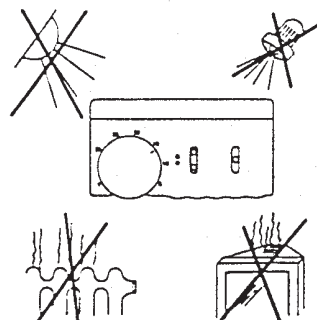
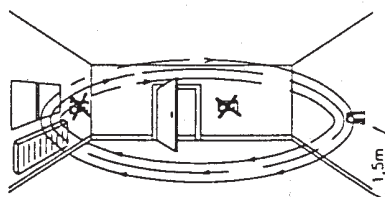
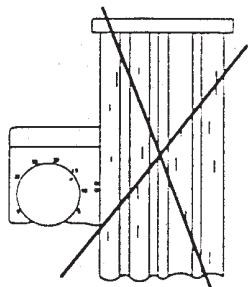
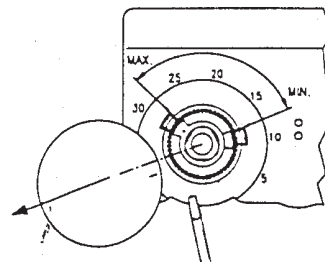
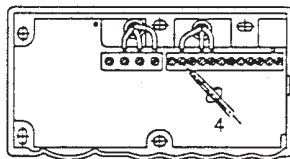
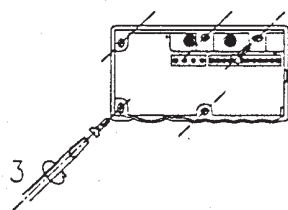
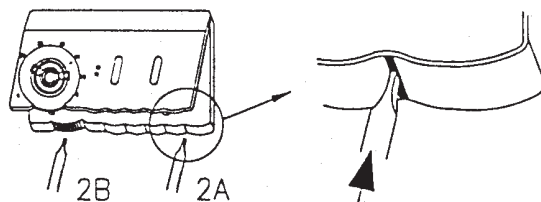
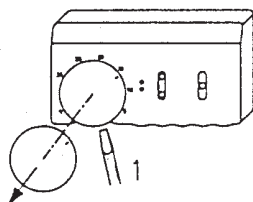

**MCI**

MATERIELS DE CONTROLÉ INDUSTRIEL

11, Rue Rabelais - 93102 MONTREUIL Cedex - Fax : 01.48.70.27.61

@ Web : [www.mci-coupatan.com](http://www.mci-coupatan.com) - eMail : [info@mci-coupatan.com](mailto:info@mci-coupatan.com)  
 ☎ Renseignements techniques : 01.49.88.28.77 / 01.49.88.28.76

# THERMOSTAT D'AMBIANCE ÉLECTRONIQUE



# METR 75810

BEDIENUNGSANLEITUNG

OPERATING INSTRUCTION

NOTICE D' UTILISATION

ISTRUZIONI D' USO

Symbol	Erklärung	Explanation	Description	Descrizione
I	Netz Ein	Mains on	Sous tension	Acceso
O	Netz Aus	Mains off	Hors tension	Spento
	Lüfter langsam	Fan low	Ventilateur petite vitesse	Basso vel.
II	mittel	Medium	Vitesse moyenne	Media vel.
	Kühlen	Cooling	Froid	Freddo
	Heizen	Heating	Chaud	Caldo

Installation  
(Example)

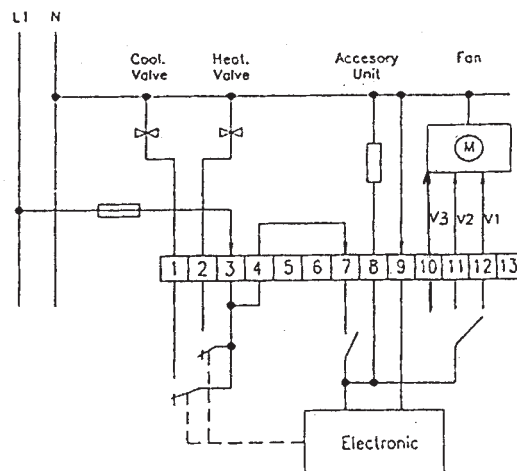

Adjustment

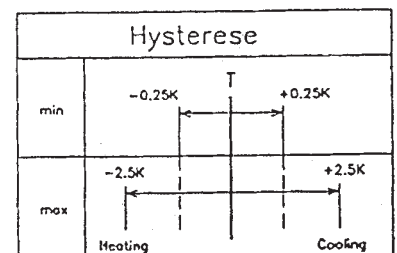
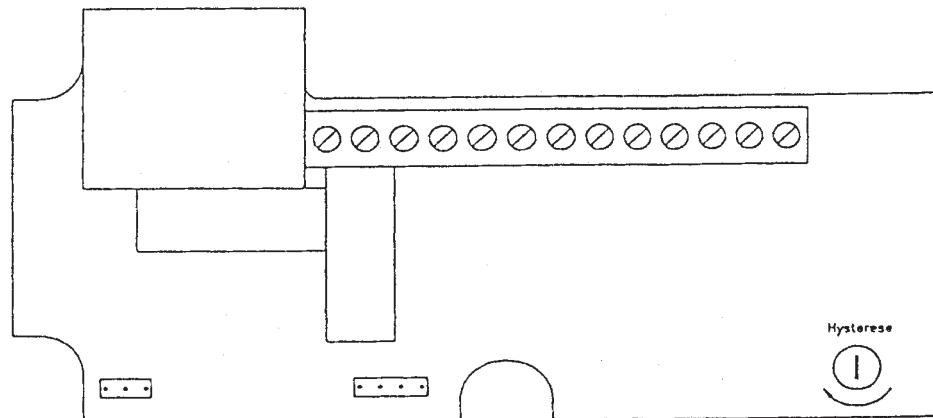

11, Rue Rabelais - 93102 MONTREUIL Cedex - Fax : 01.48.70.27.61